

---

# ОКОННАЯ СИСТЕМА REHAU ECOSOL-DESIGN 60

ТЕХНИЧЕСКАЯ ИНФОРМАЦИЯ

СЕЧЕНИЕ ПРОФИЛЕЙ



# ECOSOL-DESIGN 60

## СЕЧЕНИЯ ПРОФИЛЕЙ

### Содержание

Профили коробок . . . . .	2
Профили импостов / поперечин . . . . .	4
Профили створок . . . . .	5
Детали для механических соединений . . . . .	9
Шаблоны . . . . .	10
Армирование . . . . .	11

# ECOSOL-DESIGN 60

## СЕЧЕНИЯ ПРОФИЛЕЙ

Профили коробок

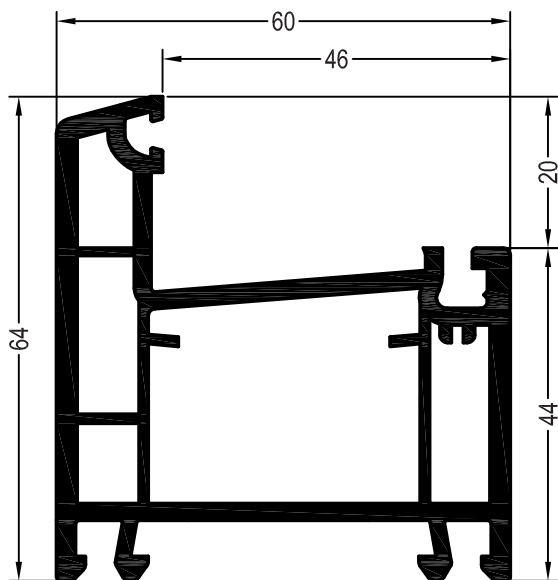





Коробка 64 Ecosol 60

557002 

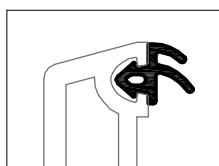
 36



Уплотнения остекления: см.  
"Указания по остеклению"

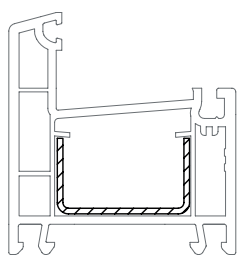

	864952
	865530
	835171



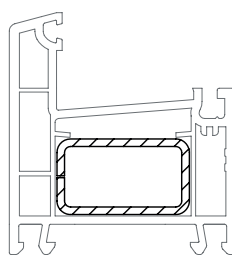

35 x 20

	245536
	1,5
lx	2
ly	0,42
	6



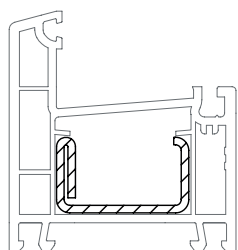

35 x 20

	239583	261709@
	1,5	2
lx	2,3	2,9
ly	0,98	1,2
	6	6



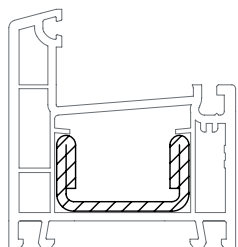

35 x 20

	261831@	261841
	1,5	2
lx	2,5	3,1
ly	0,56	0,69
	6	6



35 x 20

	245526
	2,5
lx	4,2
ly	0,89
	6

# ECOSOL-DESIGN 60

## СЕЧЕНИЯ ПРОФИЛЕЙ

Профили коробок

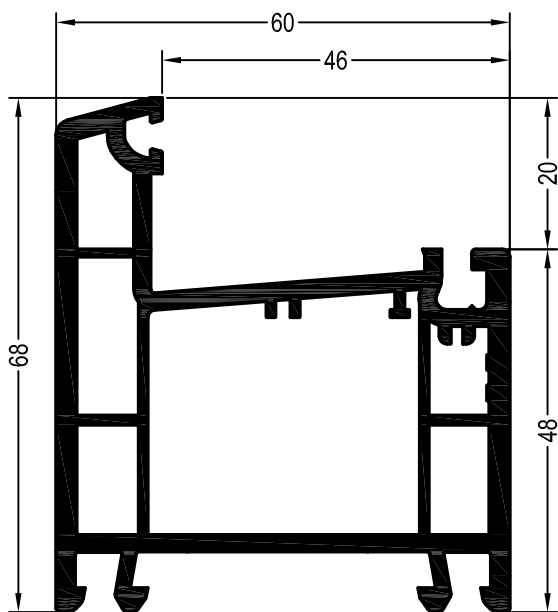





Коробка 68 Ecosol 60

1557042 

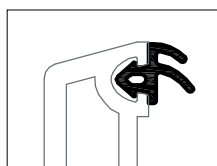
 39/585



Уплотнения остекления: см.  
"Указания по остеклению"

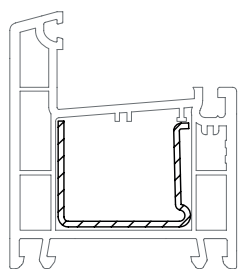

	864952
	865530
	835171



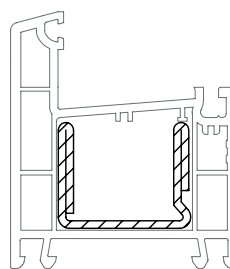

35 x 28

	244506
	1,5
lx	2,5
ly	1,1
	6



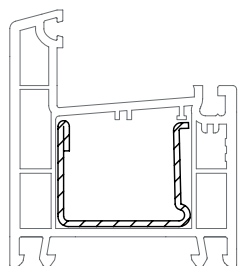

35 x 28

	244536
	2
lx	5
ly	2
	6



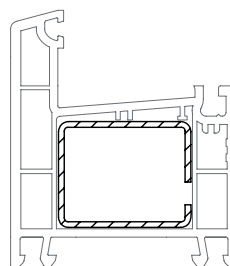

35 x 28

	244516	244526
	1,5	2
lx	2,7	3,4
ly	1,3	1,7
	6	6



35 x 28

	237091	249934
	1,5	2
lx	2,8	3,5
ly	2,1	2,7
	6	6

# ECOSOL-DESIGN 60

## СЕЧЕНИЯ ПРОФИЛЕЙ

Профили импостов / поперечин

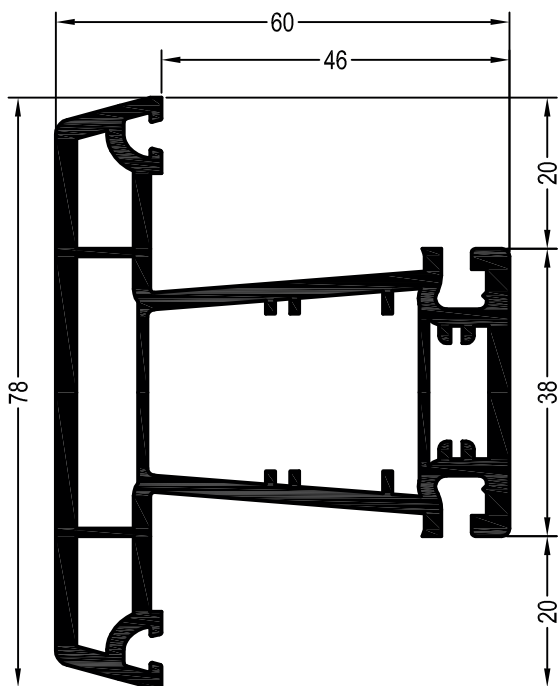





Импост 78 Ecosol 60

557022 

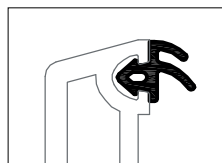
 36



Уплотнения остекления: см.  
"Указания по остеклению"

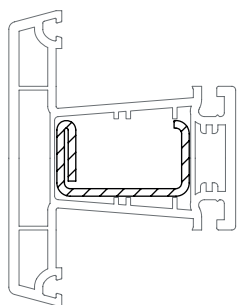

	864952
	865530
	835171



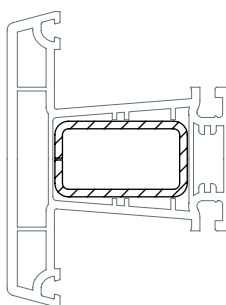

35 x 20

	261831@	261841
	1,5	2
lx	2,5	3,1
ly	0,56	0,69
	6	6



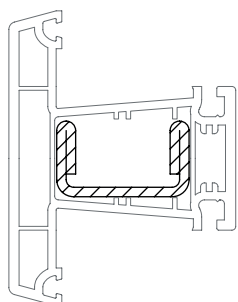

35 x 20

	239583	261709@
	1,5	2
lx	2,3	2,9
ly	0,98	1,2
	6	6



35 x 20

	245526
	2,5
lx	4,2
ly	0,89
	6

# ECOSOL-DESIGN 60

## СЕЧЕНИЯ ПРОФИЛЕЙ

Профили створок

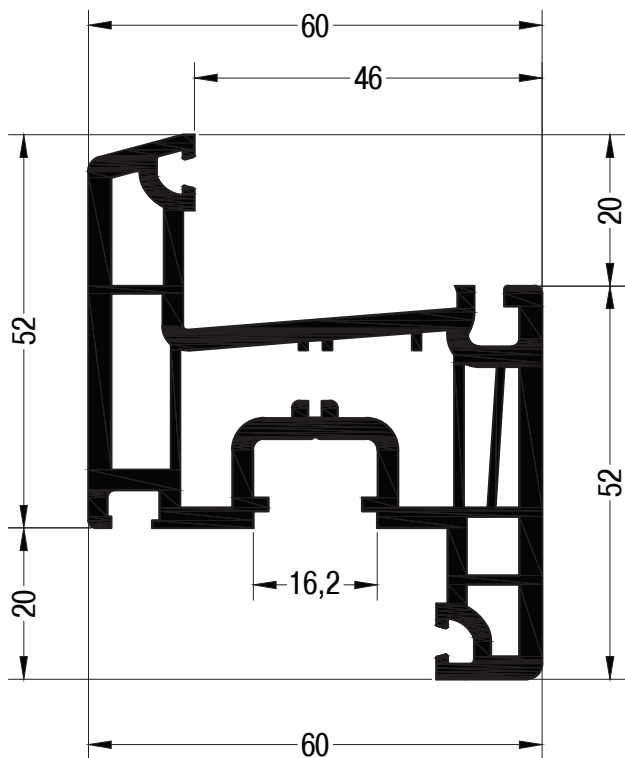





Створка Z52 Ecosol 60

557032 

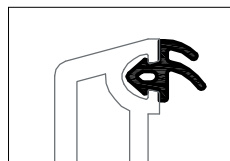
 36



Уплотнения остекления: см.  
"Указания по остеклению"

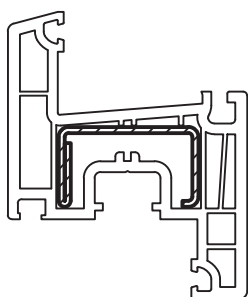

	864952
	865530
	835171



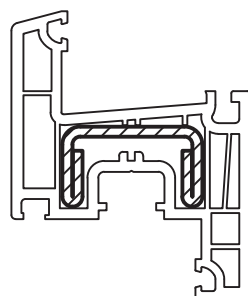

35 x 20

	261831@	261841
	1,5	2
lx	2,5	3,1
ly	0,56	0,69
	6	6



35 x 20

	245526
	2,5
lx	4,2
ly	0,89
	6

# ECOSOL-DESIGN 60

## СЕЧЕНИЯ ПРОФИЛЕЙ

Профили створок

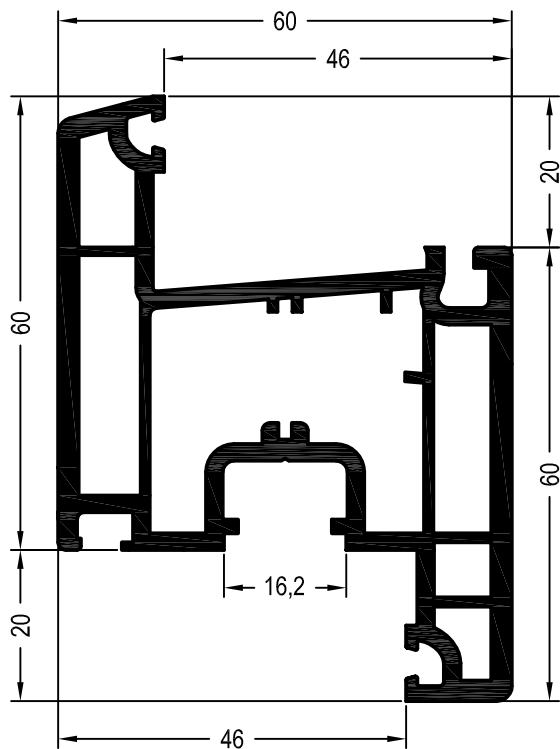





Створка Z60 Ecosol 60

557012 

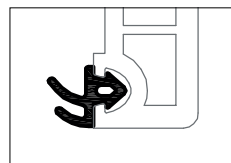
 36



Уплотнения остекления: см.  
"Указания по остеклению"

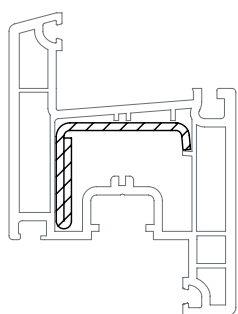

	864952
	865530
	835171



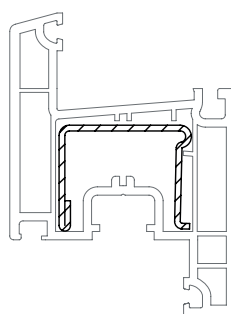

35,5 x 28

	244546@
	2
lx	2,2
ly	1,3
	6



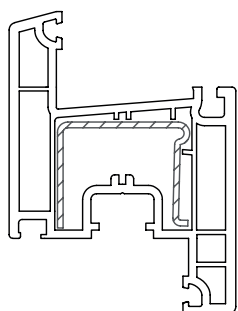

35 x 28

	244516	244526
	1,5	2
lx	2,7	3,4
ly	1,3	1,7
	6	6



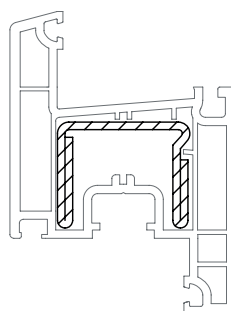

35 x 28

	244506
	1,5
lx	2,5
ly	1,1
	6



35 x 28

	244536
	2
lx	5,0
ly	2,0
	6



# ECOSOL-DESIGN 60

## СЕЧЕНИЕ ПРОФИЛЕЙ

Профили створок

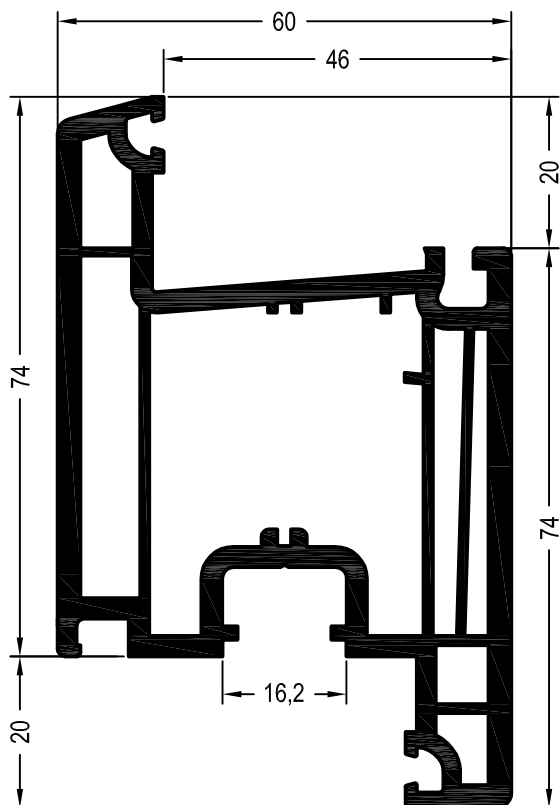





Створка Z74 Ecosol 60

1557062 

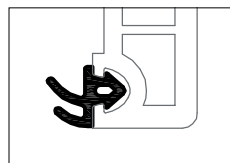
 39/468



Уплотнения остекления: см.  
"Указания по остеклению"

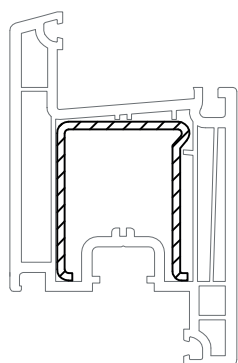

	864952
	865530
	835171



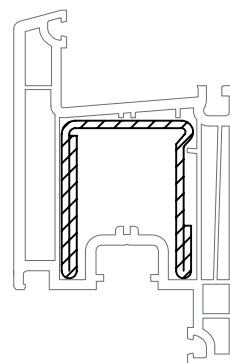

35 x 42

	350193
	2
lx	4,5
ly	4,3
	6



35 x 42

	238570@
	2
lx	6,5
ly	6,1
	6

# ECOSOL-DESIGN 60

## СЕЧЕНИЯ ПРОФИЛЕЙ

Профили створок

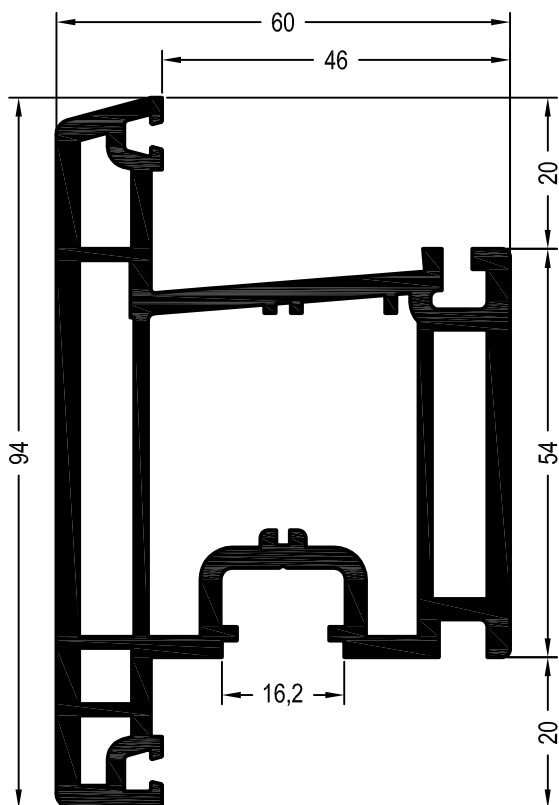





Створка T94 Ecosol 60

1557052 

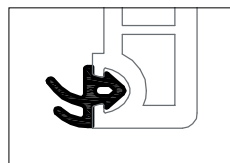
 26/416



Уплотнения остекления: см.  
"Указания по остеклению"

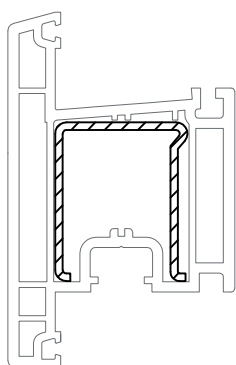

	864952
	865530
	835171



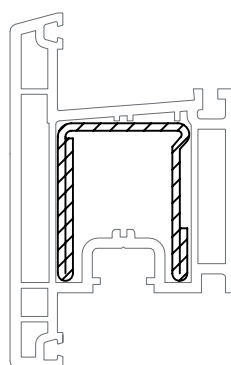

35 x 42

	350193
	2
lx	4,5
ly	4,3
	6



35 x 42

	238570@
	2
lx	6,5
ly	6,1
	6

# ECOSOL-DESIGN 60

## СЕЧЕНИЯ ПРОФИЛЕЙ

Детали для механических соединений

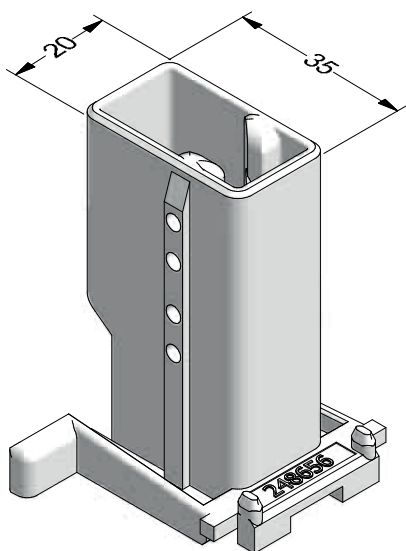

Механический соединитель импоста 78

РА

248656   

 100

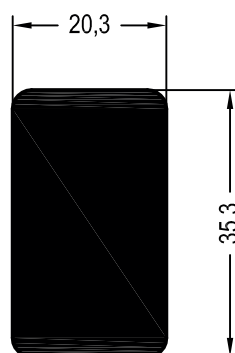

Механический соединитель



импоста 78 универсальный

247167 

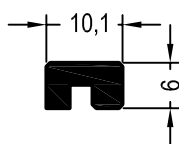
 2



Профиль фиксирующий

261699  

 36

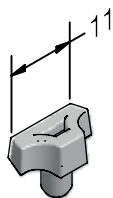

Фиксатор универсальный

АSА

268381  @

 500

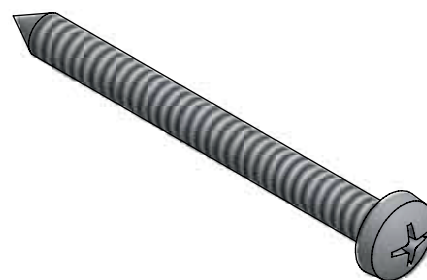

Шуруп 6,3 x 70

Сталь оцинкованная

260633 

 250

# ECOSOL-DESIGN 60

## СЕЧЕНИЕ ПРОФИЛЕЙ

### Шаблоны

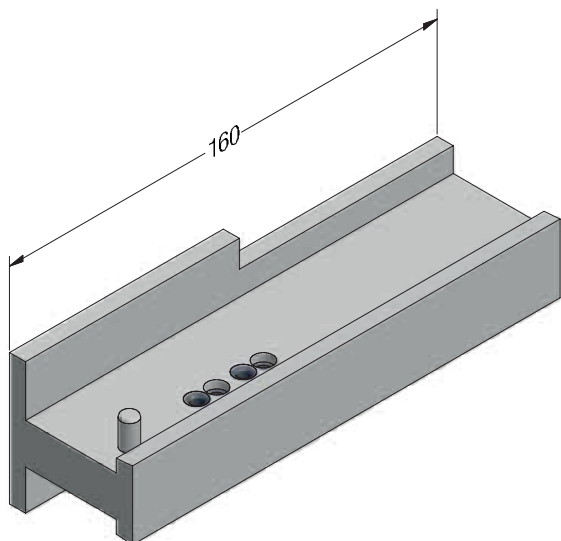

Шаблон импоста

268512 

 1

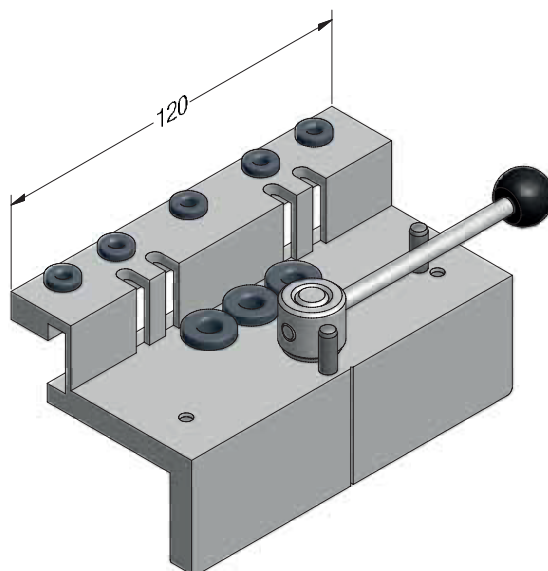

Шаблон коробки (для импоста 78)

243536 

 1

# ECOSOL-DESIGN 60

## СЕЧЕНИЯ ПРОФИЛЕЙ

### Армирование

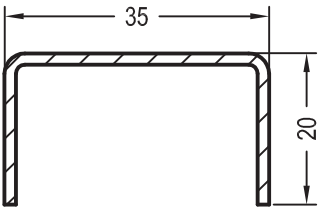
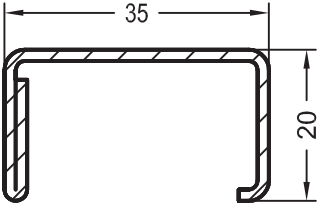
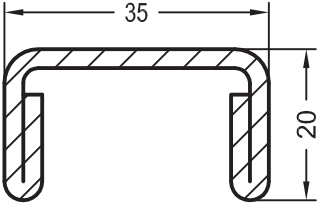
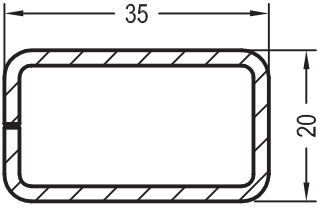
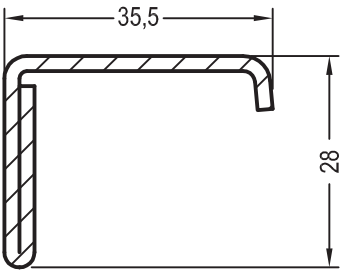
Эскиз	№ арт.	→↯← мм	Ix см <sup>4</sup>	Iy см <sup>4</sup>
	245536	1,5	2,0	0,42
	261831@	1,5	2,5	0,56
	261841	2	3,1	0,69
	245526	2,5	4,2	0,89
	239583	1,5	2,3	0,98
	261709 @	2	2,9	1,2
	244546 @	2	2,2	1,3

# ECOSOL-DESIGN 60

## СЕЧЕНИЯ ПРОФИЛЕЙ

Армирование

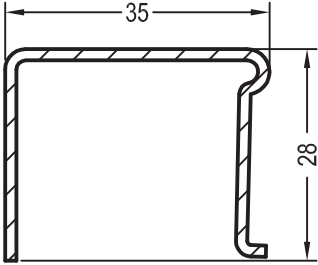
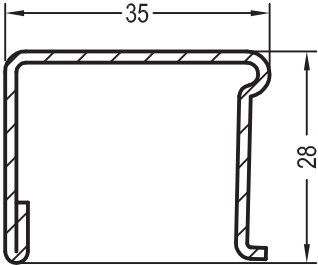
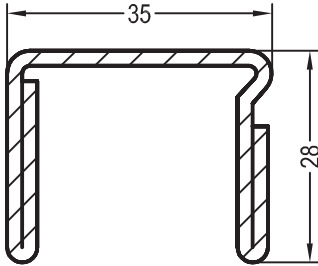
Эскиз	№ арт.	 мм	I <sub>x</sub> см <sup>4</sup>	I <sub>y</sub> см <sup>4</sup>
	244506	1,5	2,5	1,1
	244516	1,5	2,7	1,3
	244526	2	3,4	1,7
	244536	2	5,0	2,0